

1180

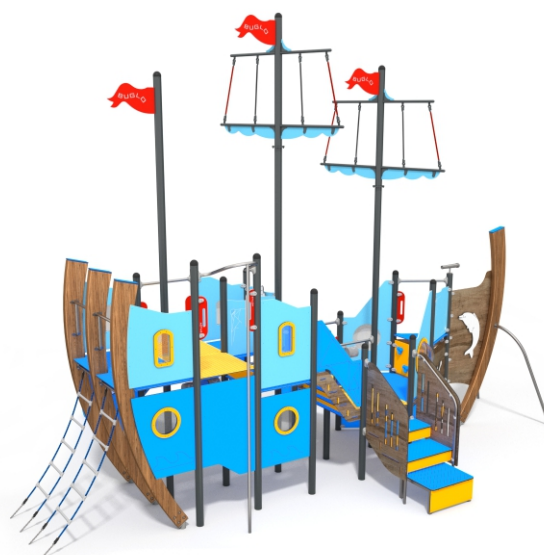







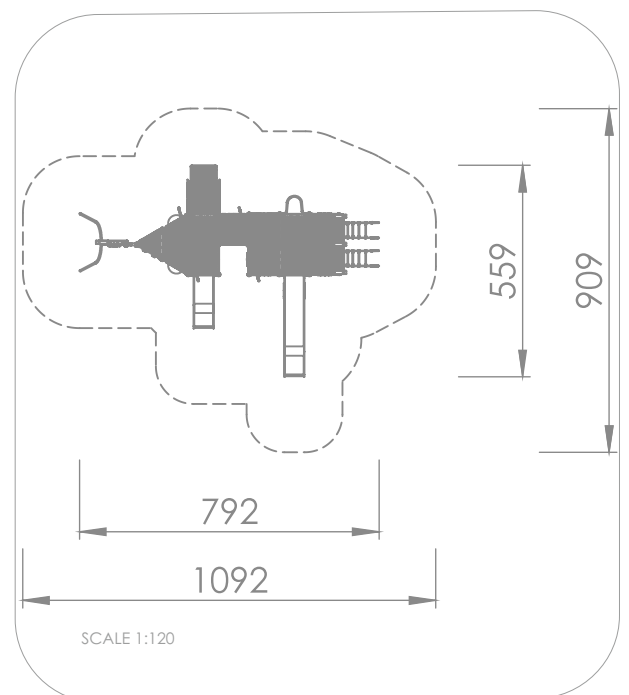
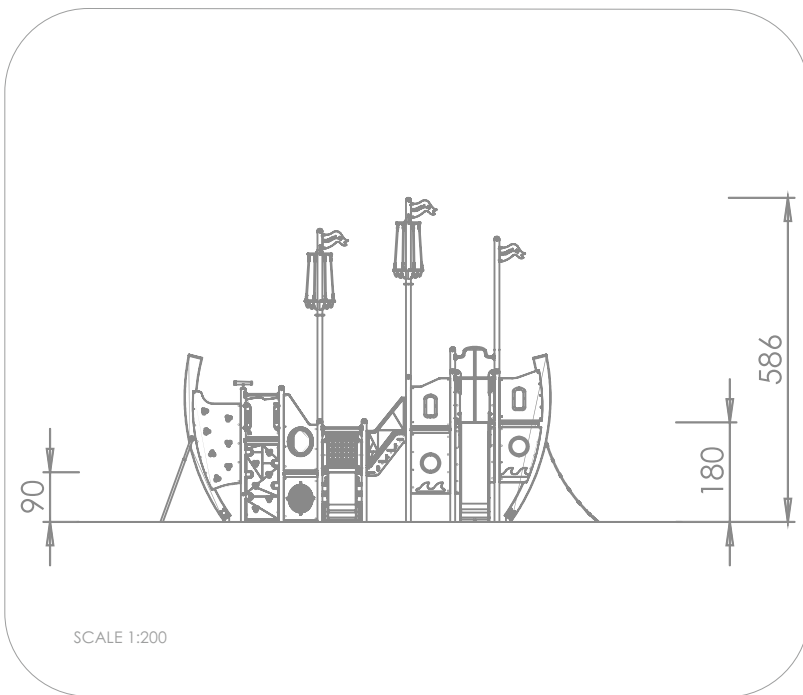
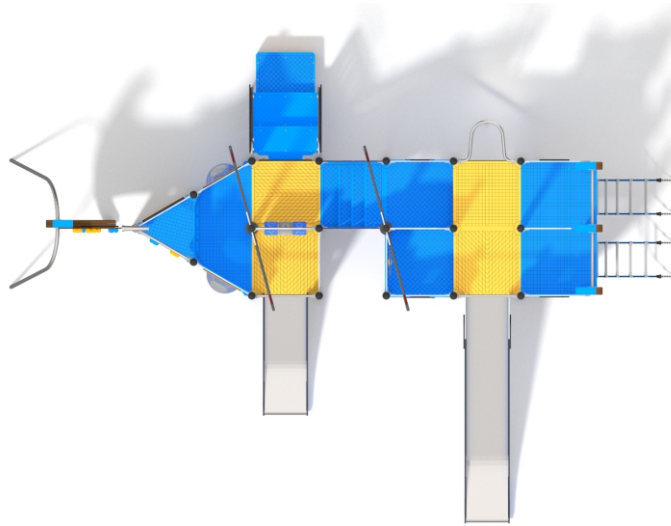

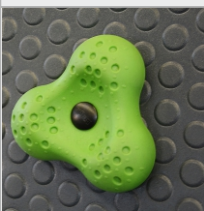

INFORMATION ABOUT THE PRODUCT

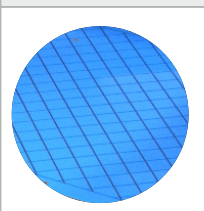
| | |
|--|-------------------|
| Dimensions | 792 x 559 cm |
| Safety zone | 1092 x 909 cm |
| Safety zone area | 66 m ² |
| Overall height | 586 cm |
| Free fall height | 180 cm |
| Amount of users | 35 |
| Product complies with EN 1176-1:2017-12 | YES |
| Availability of spare parts | YES |
| Age range | 3-12 |
| According to EN 1176-1:2017-12 norm, the product requires applying a safety surface according to the product's free fall height. | |



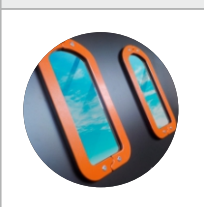
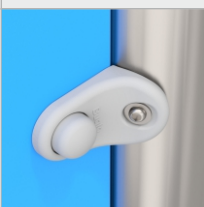

MATERIALS:

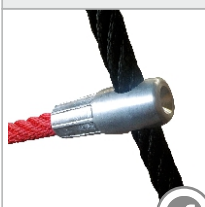
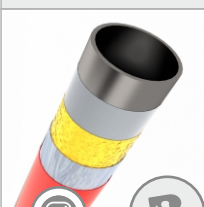
| | | | | | | |
|--|---|--|--|---|---|---|
| <p>CLIMBING ROCKS MADE OF CHIPPINGS AND COLOURFUL POLYESTER RESIN</p>  | <p>PLATES OF THE WALLS MADE OF COLOURFUL TRIPLE LAYERED 15 MM HDPE POLYETHYLENE, IN THE HIGHEST QUALITY</p>  | <p>ANTI-SLIP BLUE 13 MM HPL PLATFORM PLATE SERIES: ACTIV</p>  | <p>THE TIC TAC TOE GAME IS MADE OF POLYETHYLENE RATIONALLY MOLDED WITH SYMBOLS ON THE FORM</p>  | <p>SOLID AND ESTHETIC ROPE CONNECTORS MADE OF INJECTION MOLDED POLYAMIDE</p>  | <p>HEMISPHERIC WINDOW WITH A DIAMETER OF 400 MM, MADE OF HEAT-FORMED POLYCARBONATE 5 MM</p>  | <p>POST ENDINGS FINISHED WITH SOFT EPDM RUBBER</p>  |
| <p>PLATES OF THE WALLS AND PLATFORMS MADE OF COLOURFUL 13 MM HPL IN THE HIGHEST QUALITY</p>  | <p>SLIDES MADE OF STAINLESS STEEL AISI 304, SIDE PANELS MADE OF HDPE POLYETHYLENE</p>  | <p>THE WINDOWS ARE MADE OF SAFE POLYCARBONATE 8 MM THICK</p>  | <p>PLATE AND ROPE CONNECTORS MADE OF INJECTION MOLDED POLYAMIDE</p>  | <p>POLYPROPYLENE ROPES PPMULTISPLIT TYPE WITH A STEEL CORE AND A DIAMETER OF 16 MM</p>  | <p>ROPE ENDINGS PRESSED IN A SLEEVE MADE OF DURABLE ALUMINUM ALLOY</p>  | <p>SOLID CONSTRUCTION MADE BLACK STEEL S235JR CLEANED IN THE SANDBLASTING PROCESS</p>  |

